

SECTION A-A

D5 FH'BI A69F'H56 @

D5 FH'BI A69F	65 @05 @CM	65 @05 @CM	Fc<G	G'8-9
SBGA484T1.0C-DC229AD	Sn96.5/Ag3.0/Cu0.5	SAC305	YES	YES
SBGA484T1.0-DC229AD	Sn63/Pb37	Sn63	NO	YES

Notes: (Unless Otherwise Specified).

- 1) ALL DIMENSIONS ARE IN MM.
- 2) SOLDER BALL ALLOY: SEE PART NUMBER TABLE.
- 3) BALL DIAMETER (BEFORE REFLOW): 0.636mm [25 MIL].
- 4) SOLDER MASK DEFINED PAD OPENING: 0.508mm [20 MIL].
- 5) PAD Cu DIAMETER: 0.636mm [25 MIL].
- 6) SUBSTRATE MATERIAL: FR4 (ALTERNATE BT).
- 7) DUMMY DIE IS OPTIONAL.
- 8) DAISY CHAIN PATTERN (SEE PAGE 2).
- 9) MSL-3 RECOMMENDED BAKING 24 HOURS @ 125°C TO REMOVE MOISTURE PRIOR TO SOLDERING TO PC BOARD.

APPROVALS	DATE	TopLine®			
DRAWN T. Au	9/26/2017				
ENG M. Hart	9/26/2017	TITLE SBGA484T1.0-DC229AD DAISY CHAIN DUMMY			
MFG		SCALE	SIZE	DRAWING NO.	REV
QA		3.5:1	A	512295	A
CUST		DO NOT SCALE DRAWING			SHEET 1 OF 5
REVISED					

BALL VIEW

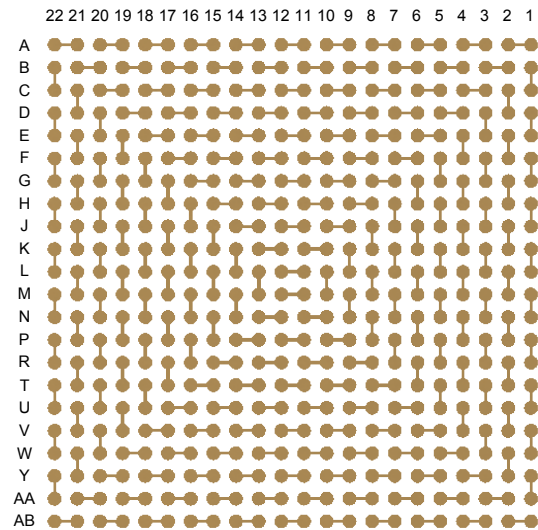

BOTTOM SIDE (TOP X-RAY VIEW)

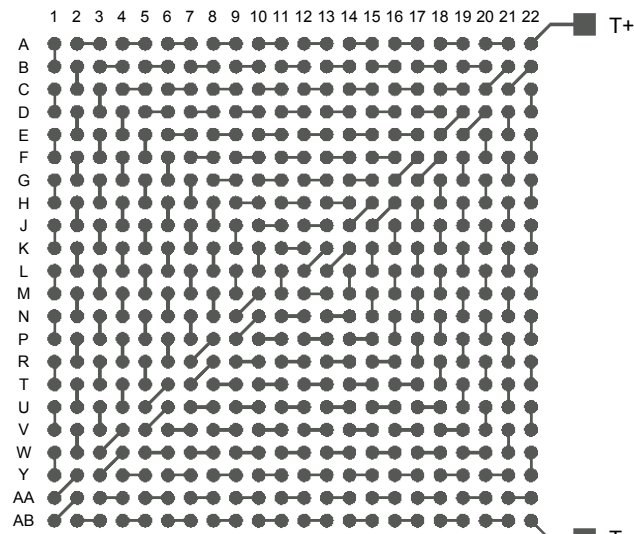
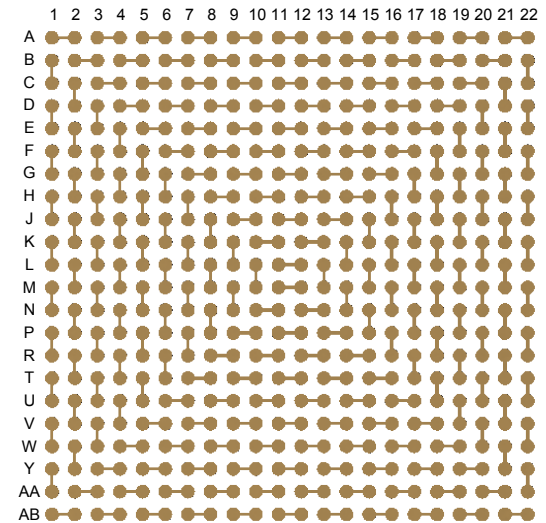

TEST VEHICLE BOARD

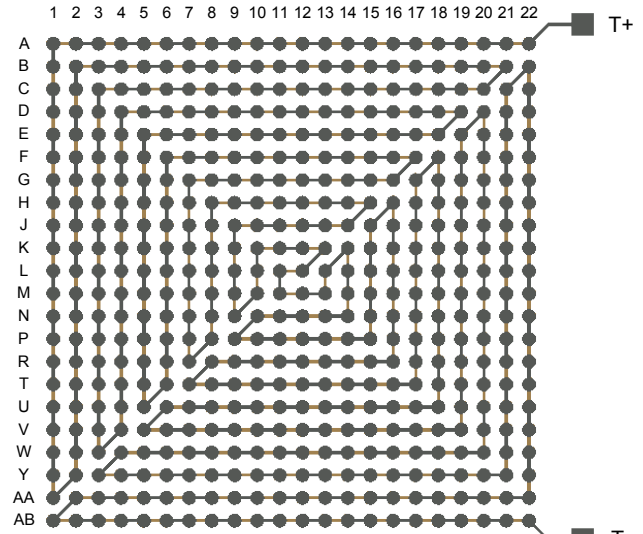

AFTER MOUNTING

Notes:

- 1) PCB BOARD DIMENSIONS ARE PRESENTED ONLY AS A GUIDELINE. DESIGNERS SHOULD USE THEIR OWN EXPERIENCE WHEN DESIGNING PCB.
- 2) PCB Cu BALL PAD DIAMETER 0.636mm [25 MIL].
- 3) PCB DAISY CHAIN TRACING LINE WIDTH 0.152mm [6 MIL].
- 4) SMD (SOLDER MASK DEFINED) PAD OPENING 0.33mm [13 MIL].



TITLE			
SBGA484T1.0-DC229AD DAISY CHAIN DUMMY			
SCALE	SIZE	DRAWING NO.	REV
3:1	A	512295	A
DO NOT SCALE DRAWING			SHEET 2 OF 5

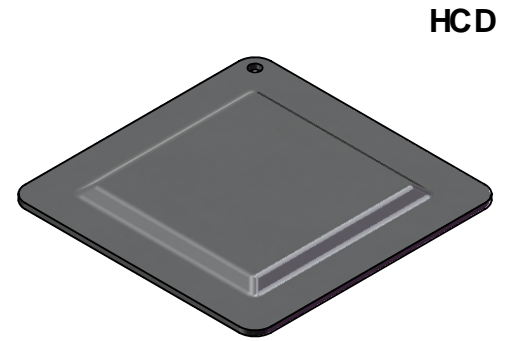
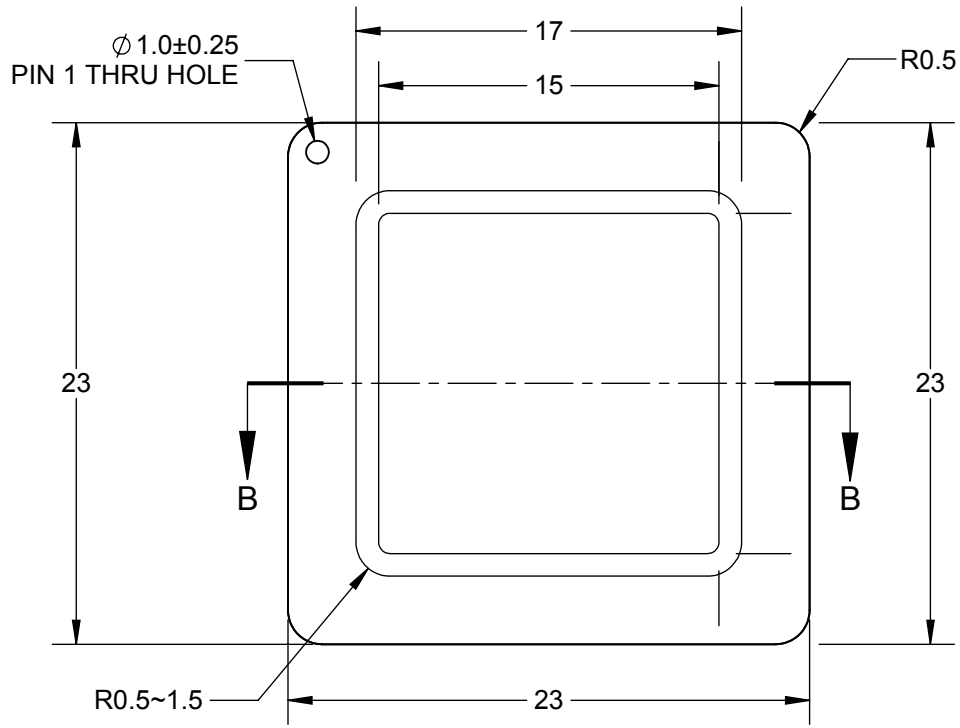

AC89@

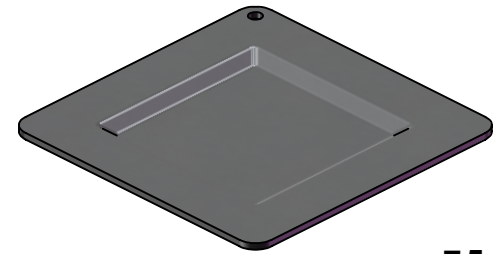

75J+M

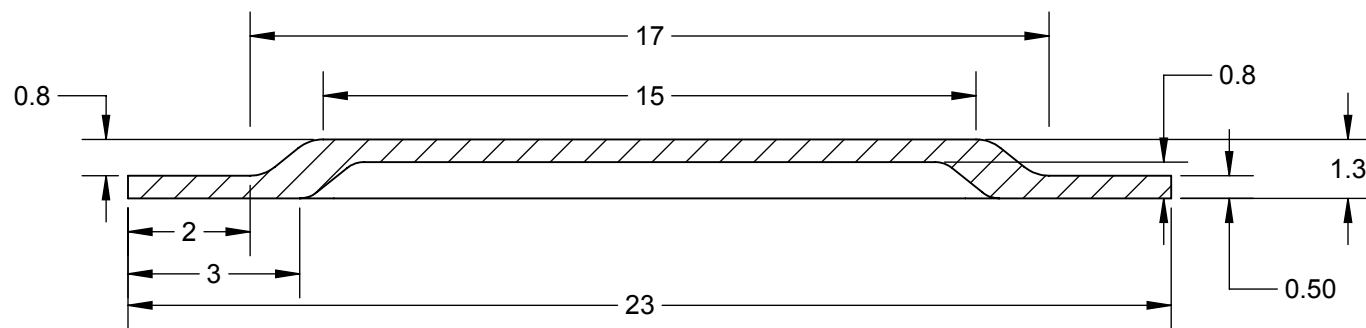

SECTION B-B
SCALE 6 : 1

TopLine®			
TITLE		SBGA484T1.0-DC229AD DAISY CHAIN DUMMY	
SCALE	SIZE	DRAWING NO.	REV
	A	512295	A
DO NOT SCALE DRAWING			SHEET 3 OF 5

HCD

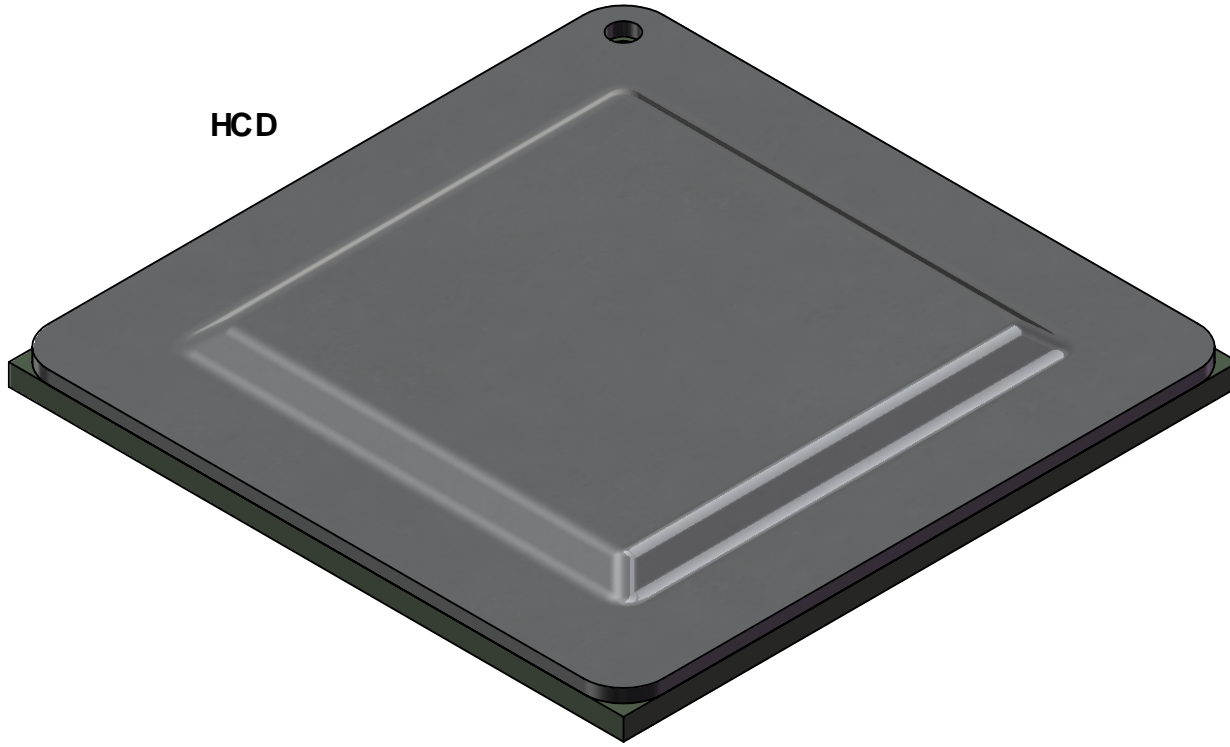

65 @@J-K

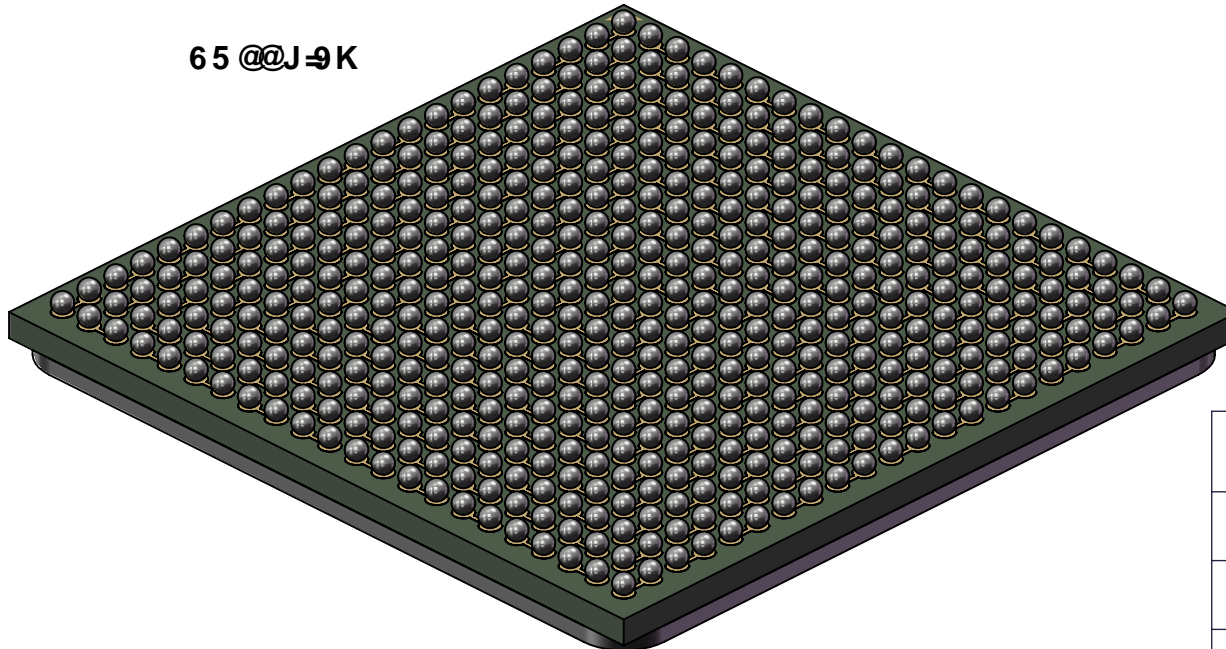

TopLine[®]

TITLE SBGA484T1.0-DC229AD
DAISY CHAIN DUMMY

SCALE	SIZE	DRAWING NO.	REV
	A	512295	A

DO NOT SCALE DRAWING

SHEET 4 OF 5

6 CHHCA GC @ 9F A5 G?
fF > < HF958 B; L

22 21 20 19 18 17 16 15 14 13 12 11 10 9 8 7 6 5 4 3 2 1

A
B
C
D
E
F
G
H
J
K
L
M
N
P
R
T
U
V
W
Y
AA
AB

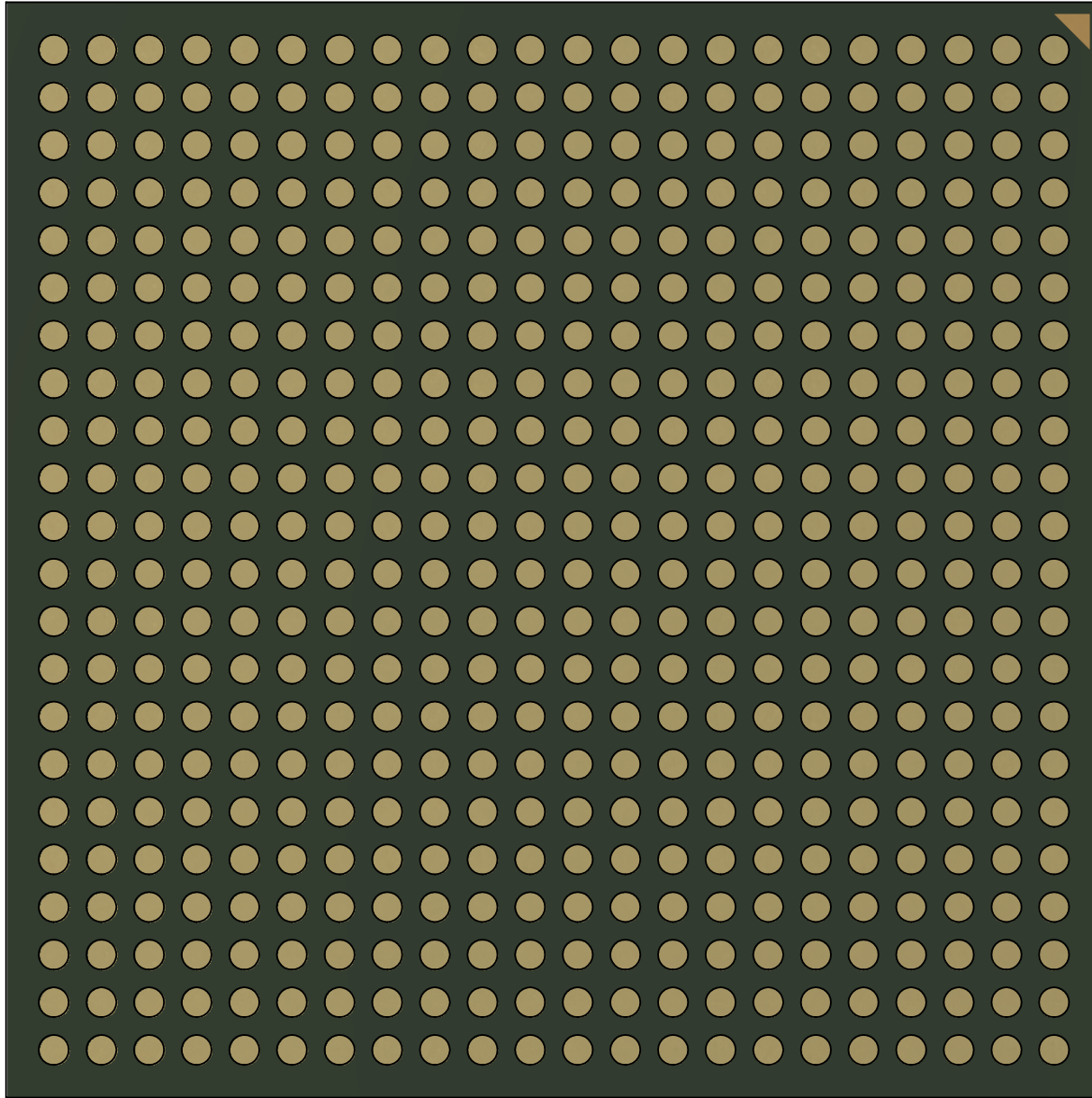

TopLine®			
TITLE		SBGA484T1.0-DC229AD DAISY CHAIN DUMMY	
SCALE	SIZE	DRAWING NO.	REV
7:1	A	512295	A
DO NOT SCALE DRAWING			SHEET 5 OF 5